

Standard / Armless

Put Green or Orange Arrows with Red or Tan Arrows to Create Sectional Groups

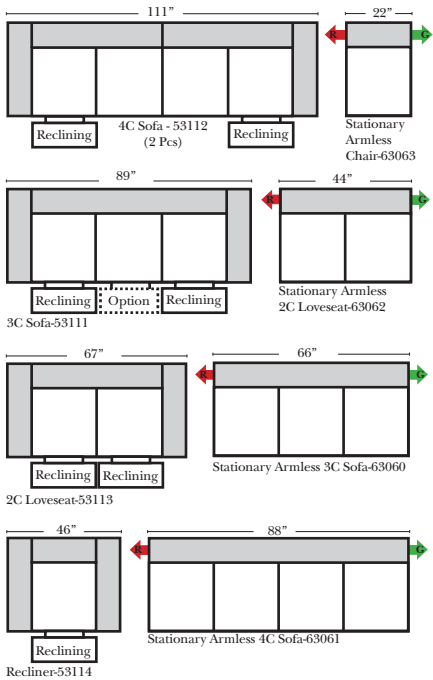

2-Piece Curve Sectional

Put Blue Arrows with Yellow Arrows to Create Sectional Groups or Green Arrows with Red Arrows to mix with some of the L-Shaped pieces.

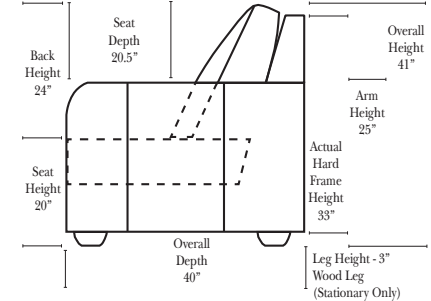
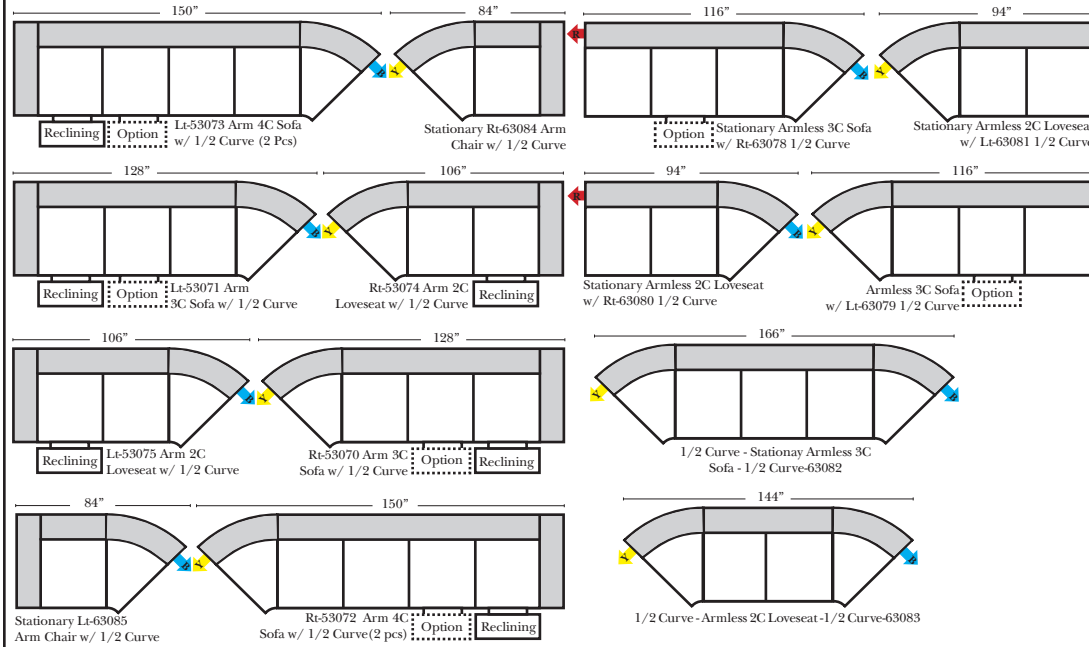

Standards & Options

Standard:

- Available in Full & Top Grain Leathers
- All Hardwood Frames
- Nail Heads
- Wood Leg Finish - Walnut Finish (Stationary Only)

Options: (No Additional Charge)

- No. 33 Firm Foam
- Wood Leg - Cherry, Chocolate, Espresso, Honey Oak, Shadow (Stationary Only)

Options: (Additional Charges Apply)

- Console Table - Standard as Espresso finish (N/C Option is Honey Oak finish)
- Metal Cup Holder (MCH) - Standard Finish is Silver (N/C Option is Black or Hammered Antique Finish)
- Electronic Cup Holder (ECH) (Console Arms Only) (Available with Motorized Reclining Seats only)
- Center Seat Recliner Option
- Motorized Recliner Mechanism
- Swivel Recliner Base (2 Arm Recliner Only)
- Swivel Glider Mechanism (2 Arm Recliner Only)
- Glider Mechanism Only (2 Arm Recliner Only)
- Lift Chair Dual Motor Mechanism (2 Arm Recliner Only)
- Upholstered Swivel Base (2 Arm Recliner Only)
- Motorized 180° Swivel Recliner (2 Arm Recliner Only)

Sleeper Options: (Additional charges apply)

- Full Sleeper available w/Standard Mattress
- Deluxe Innerspring Mattress: Full
- Air Dream Coil Mattress: Full Only



Note:

All Dimensions are approximate, if accuracy is crucial, please contact us for validation of the dimensions shown. However, a 1" to 2" variance can still apply due to foam and upholstery.

All items on these pages are available as Stationary (Non-Reclining)

90 Degree / L-Shape Sectional

Put Green or Orange Arrows with Red or Tan Arrows to Create Sectional Groups

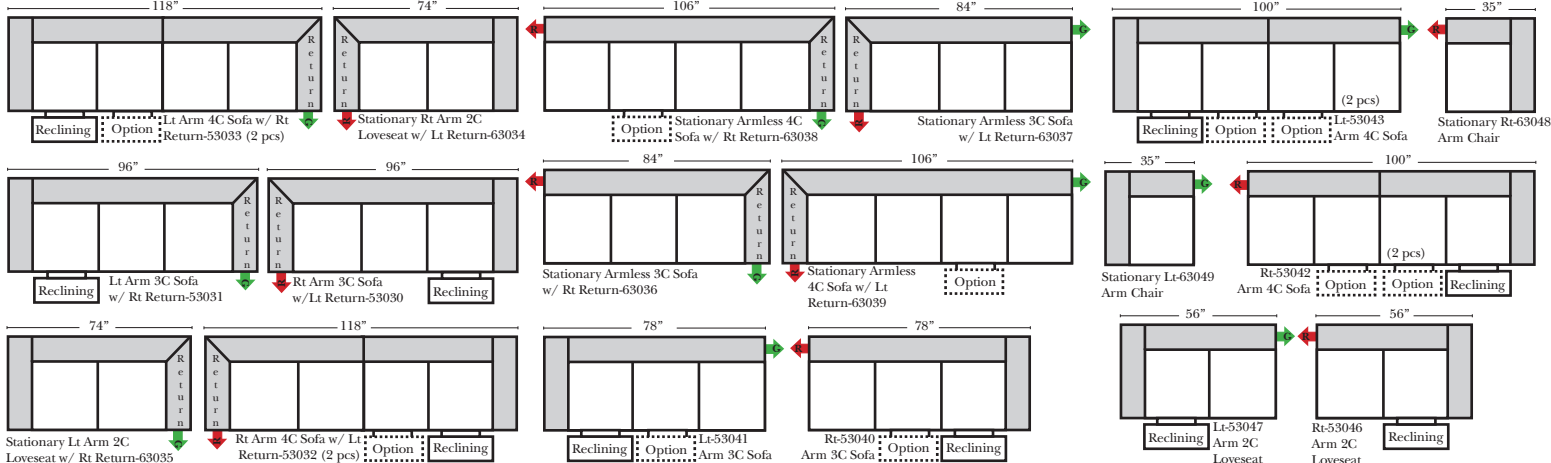

Bumper / Return Chaise & Conversation Sofas

Put Green Arrows with Red Arrows to Create Sectional Groups
Put Orange Arrows with Tan Arrows to Create Sectional Groups

Put Blue Arrows with Yellow Arrows to Create Sectional Groups

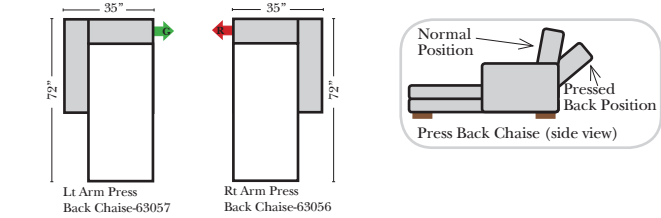

All Ottomans have a height of 19"

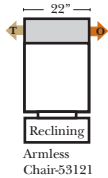
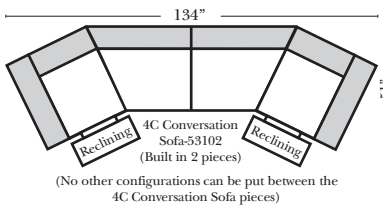
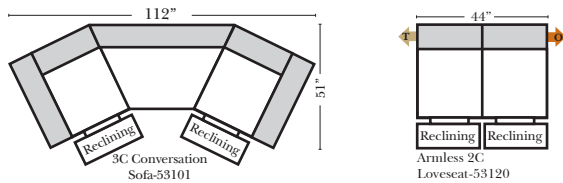
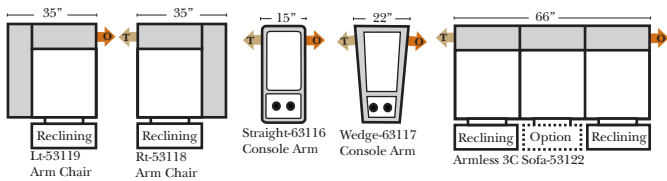
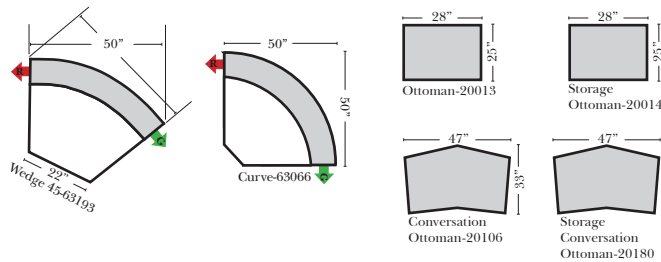

Sleepers

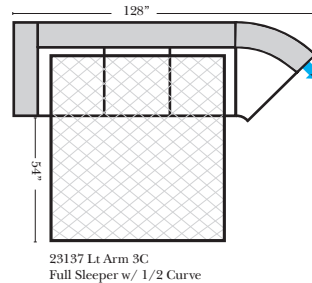
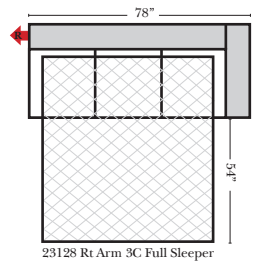
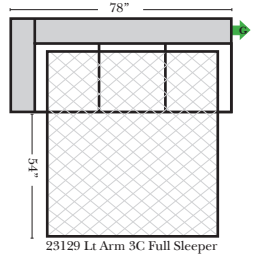
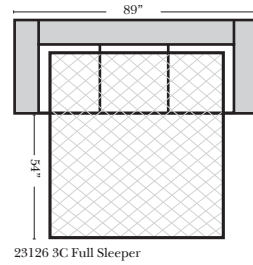

Suggested Configurations

v.11.23.15

The Suggested Configurations below are only a sample of what the imagination can create, please enjoy creating the configuration that fits your lifestyle, using the ideas below and from the items on the opposite page.

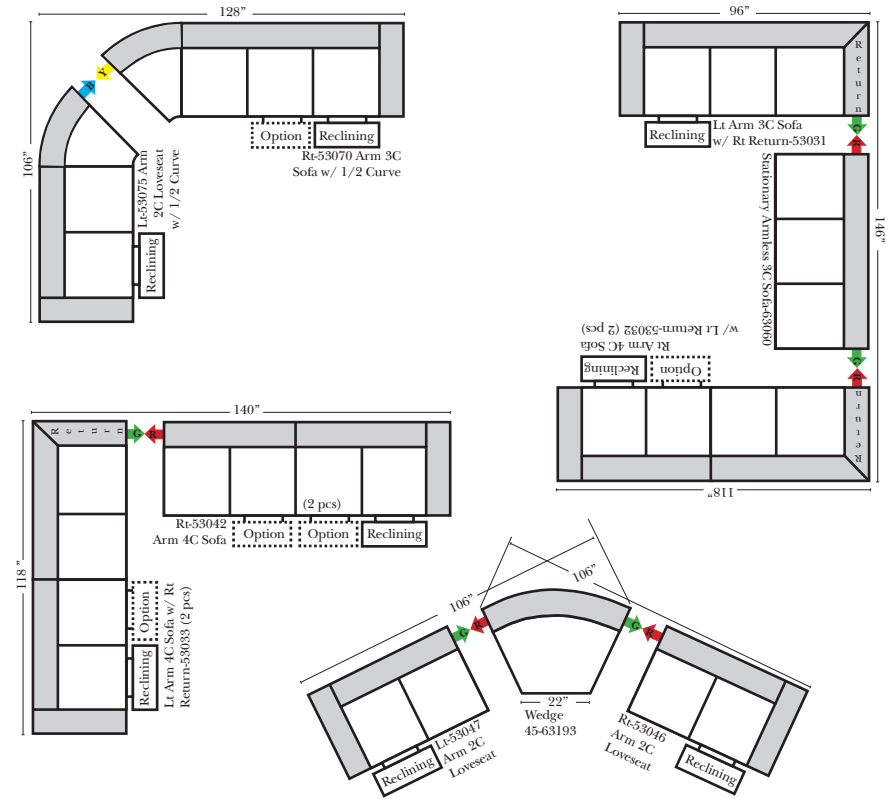

Sleepers (cont.)

